

<b>METROPOLITAN UTILITIES DISTRICT</b>	<b>Construction Standard</b>	No: <b>11.2.3</b>
	Butt-Fusion	Page: 1 of 8
Prepared by: Bill Travnicsek		<a href="#">Supersedes:</a> 7-11-11
Approved by: Jeff Loll		Effective: 10-1-12

## A. GENERAL

- \* The Plastic Pipe Institute (PPI) developed standardized butt-fusion procedures which are labeled by the industry as “[Generic Butt-Fusion Procedures](#)”. These procedures have been adopted by most of the MDPE 2406/2708 and HDPE 3408/4710 pipe manufacturers including the three District approved companies, Performance Pipe, Polypipe, and JM Eagle. The Generic procedures were tested and qualified by all three companies to join their own MDPE to MDPE, HDPE to HDPE, and MDPE to HDPE pipe as well as join to each other’s pipe. The District has adopted PPI’s “[Generic Butt-Fusion Procedures](#)”. Any Contractor performing butt-fusion for the District, must qualify on M.U.D.’s butt-fusion procedure or provide documentation that their butt-fusion procedure is qualified and documentation their fusion personnel are qualified on their procedures. This must be approved by M.U.D.

*Note: It is a common practice and accepted industry “Rule of Thumb” when fusing pipes of unlike SDR’s to fuse a maximum mismatch of one SDR.*

## B. PARAMETERS FOR THE PPI GENERIC BUTT-FUSION PROCEDURE

### 1. Heating tool surface temperature --- minimum 400°F --- maximum 450°F.

*Note: M.U.D. has standardized the heater plate temperature at  $425^{\circ}\text{F} \pm 10^{\circ}\text{F}$  so that a qualified individual can go from one crew to another and the temperature settings are approximately the same.*

### 2. Interface pressure should be --- minimum 60 psi --- maximum 90 psi.

*Note: Interface pressure is used to calculate a fusion joining pressure value for hydraulic butt fusion machines. The same interface pressure is used for all pipe sizes. However, fusion joining pressure settings for the hydraulic butt fusion machine are calculated for each pipe OD and DR. Interface pressure, fusion surface area, carriage cylinder size, internal drag pressure, and, if necessary, the pressure needed to overcome external drag resistance are used to calculate the hydraulic fusion joining pressure gauge setting. The equipment manufacturer’s instructions are used to calculate this value.*

M.U.D. uses the hand operated McElroy 14 Butt-fusion Machine for 4" and smaller P.E. pipe. The procedure is visual, except for the cooling times. The hydraulic operated McElroy 28 Butt-fusion Machine is used to join 6" and 8" IPS P.E. pipe and the McElroy 618 hydraulic Butt-fusion Machine to join 10" through 18" IPS P.E. pipe. The heating cycle procedure for the hydraulic 28 and 618 machines is visual, the facing procedure is performed by hand controlled hydraulic pressure, the fusion procedure is performed with pre-set hydraulic pressure, and the cooling cycle is timed. Successful fusion depends on proper facing, pipe alignment, melting, joining, and cooling.



<b>METROPOLITAN UTILITIES DISTRICT</b>	<b>Construction Standard</b>	No: <b>11.2.3</b>
	Butt-Fusion	Page: 2 of 8
Prepared by: Bill Travnicsek		<a href="#">Supersedes:</a> 7-11-11
Approved by: Jeff Loll		Effective: 10-1-12

### **C. THEORY OF BUTT FUSION**

The principle of heat fusion is to heat two surfaces to a designated temperature, and then fuse them together by application of force. This pressure causes flow of the melted materials, which causes mixing and thus fusion. When the polyethylene pipe is heated, the molecular structure is transformed from a crystalline state into an amorphous condition.

When fusion pressure is applied, the molecules from each pipe end mix. As the joint cools, the molecules return to their crystalline form, the original interfaces are gone, and the two pipes have become one homogeneous pipe. The joint area becomes stronger than the pipe itself in both tensile and pressure conditions. The principle operations include:

- Clamping** The pipe pieces held axially to allow all subsequent operations to take place.
- Facing** The pipe ends must be faced to establish clean, parallel mating surfaces perpendicular to the centerline of the pipes.
- Aligning** The pipe ends must be aligned with each other to minimize mismatch or high-low of the pipe walls.
- Heating** A melt pattern that penetrates into the pipe must be formed around both pipe ends.
- Joining** The melt patterns must be joined with a specified force. The force must be constant around the interface area.
- Holding** The molten joint must be held immobile with a specified force until adequately cooled.
- Inspecting** Visually examine the entire circumference of the joint for compliance with standards established by your company, customer, industry, federal, state, or local regulations. Each pipe manufacturer has a slightly different approach for fulfilling the heating, joining, and holding phases, but the end result is the same -- a fusion joint that is as strong or stronger than the pipe itself.

### **D. BUTT-FUSION PROCEDURE (McElroy 14 Machine)**

**NOTE:** The McElroy 28 and 618 Hydraulic Butt-Fusion machine's operating procedures are contained in the "Operator's Manuals" kept with the machines. A complete copy of the [McElroy 28 Operator's Manual](#) and [McElroy 618 Operator's Manual](#) are kept on computer and may be printed if needed.

Operator's Manuals were not provided with the McElroy 14 machines at the time of purchase. Therefore, the following procedures for the McElroy 14 Butt-Fusion Machine contain the actual operating steps only. A complete copy of the [McElroy 14 Operator's Manual](#), including maintenance information, is kept on computer and may be printed if needed by selecting the above link.

<b>METROPOLITAN UTILITIES DISTRICT</b>	<b>Construction Standard</b>	No: <b>11.2.3</b>
	Butt-Fusion	Page: 3 of 8
Prepared by: Bill Travnicsek		<a href="#">Supersedes:</a> 7-11-11
Approved by: Jeff Loll		Effective: 10-1-12

All text in *italics* indicate additional steps, precautions, and observations that the District has developed over many years of experience with butt-fusion using the McElroy 14 Butt-fusion machine. Most of them also pertain to the operating procedures for the 28 and 618 machines. The District believes them to be important enough to include them in the butt-fusion procedures. The additional steps, precautions, and observations do not alter the basic butt-fusion steps qualified by the District's three approved pipe manufacturers and do not require the procedures to be re-qualified.

- 1. Prepare Heater** - Heater Is Not Explosion Proof. Operation of heater in a hazardous environment without necessary safety precautions will result in explosion and death.

If operating in a hazardous environment, heater should be brought up to temperature in a safe environment, then unplugged before entering the hazardous atmosphere for fusion.

Install butt fusion heater adapters.

**NOTICE:** The heater should never be used without butt fusion heater adapters installed. Refer to the "Maintenance" section of this manual for installation procedure.

Place heater in insulated heater stand.

Plug heater into a proper power source.

Allow heater to warm-up to operating temperature.

Refer to the "Maintenance" section of this manual for instructions how to adjust heater temperature.

- 2. Install Clamping Inserts** - Select and install appropriate clamping inserts for the pipe that is being fused.

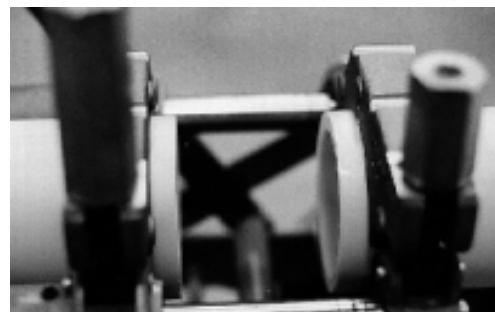
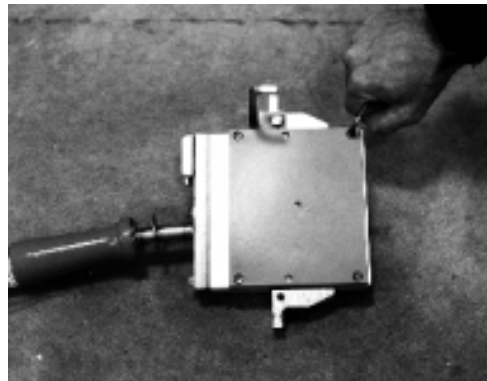

<b>METROPOLITAN UTILITIES DISTRICT</b>	<b>Construction Standard</b>	No: <b>11.2.3</b>
		Page: 4 of 8
Prepared by: Bill Travnicsek	<b>Butt-Fusion</b>	<a href="#">Supersedes:</a> 7-11-11
Approved by: Jeff Loll		Effective: 10-1-12

- 3. Loading Pipe Into Machine** - Clean the inside and outside of the component (pipe or fitting) ends by wiping with a clean dry, lint-free cloth or paper towel. Remove all foreign matter, such as the plastic protective end caps that may be lodged inside the pipe. When working with coiled pipe, if possible “S” the pipes on each side of the machine to compensate for coil curvature and make it easier to join.



Open the upper jaws and insert pipe in each pair of jaws with applicable inserts installed. Let the ends of the pipe protrude about 1" past the face of the jaws.

- 4. Positioning Pipe in Machine** - Insert the facing unit with the handle on the same side as the fusion machine slide handle. Position the facer on the guide rods and lock into position. Using lever handle, bring pipe ends together against the facer, watching the gap between the facer stops and the pipe clamping jaws. Leave enough **gap** so that proper face-off will be achieved when the facer stops are bottomed out against the clamps. Tighten the pipe clamp knobs until firm resistance is felt. Do not over-tighten.



**NOTE:** Thoroughly clean all dirt and debris from pipe ends before facing.

- 5. Facing the pipe** - Close the slide until the pipe ends are touching the facer blades. Turn the facer on and use the slide handle to gently push the pipe ends into the blades. Advance the ends until the slide is against the travel stops. Turn the facer off and wait until the blades come to a stop. Pull the slide handle back and remove the facer. Complete facing produces continuous circumferential shavings from both ends.

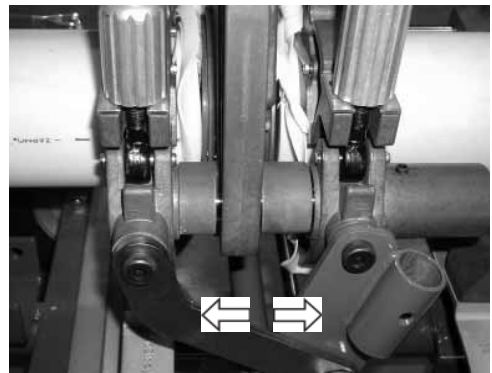

Unlatch and remove facer. Remove shavings from pipe ends and machine. Do not touch faced pipe ends.

Inspect both pipe ends for complete face off. If the face off is incomplete, return to **Loading Pipe Into Machine**.

<b>METROPOLITAN UTILITIES DISTRICT</b>	<b>Construction Standard</b>	No: <b>11.2.3</b>
	<b>Butt-Fusion</b>	Page: 5 of 8
Prepared by: Bill Travnicek		<a href="#">Supersedes:</a> 7-11-11
Approved by: Jeff Loll		Effective: 10-1-12

- 6. Check Alignment of Pipe** - Bring the pipe ends together and check for alignment. If high/low (misalignment) exists, adjust by tightening the high side clamp. When pipe is properly aligned, tighten both clamps simultaneously to ensure against pipe slippage.

**NOTE:** When clamping, do not over-tighten the clamp knobs because machine damage can result. Check to see if there is space between the upper and lower jaws. If the two jaws are touching, do not continue to tighten. Bring the pipe ends together under fusion pressure to check for slippage. If slippage occurs, return to **Loading Pipe into Machine**.

*Note: Re-face if high-low alignment is adjusted.*

*Check again for high-low alignment of outside diameters and complete contact all around both ends with no detectable gaps. The jaws must not be loosened or the pipe may slip during fusion. If the jaws are loosened, for any reason, go back to **Loading Pipe Into Machine** and repeat the steps.*

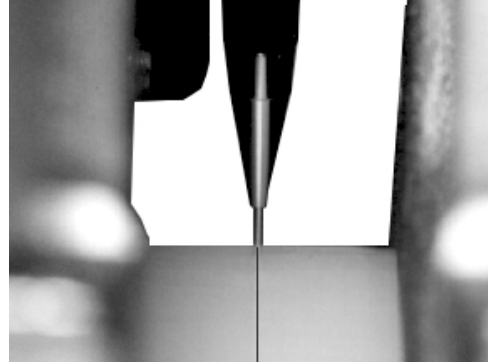

- 7. Check Heater Temperature** - Incorrect heating temperature can result in questionable fusion joints. Check heater plates periodically with a pyrometer and make necessary adjustments to bring the temperature to  $425^{\circ} \pm 10^{\circ}$ . This check can be performed at the plant, on site, or by the Training Foreman.



**IMPORTANT:** The dial thermometer on the heater indicates internal temperature which varies from the actual surface temperature.

The dial thermometer can be used as reference once the surface temperature has been verified.

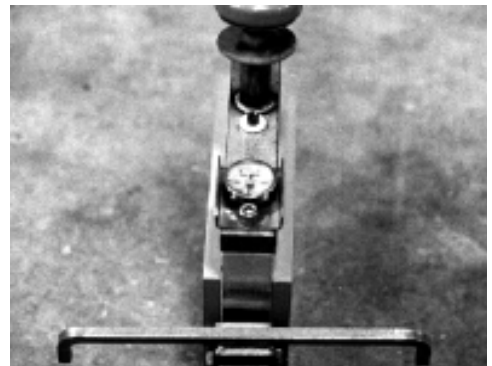

<b>METROPOLITAN UTILITIES DISTRICT</b>	<b>Construction Standard</b>	No: <b>11.2.3</b>
		Page: 6 of 8
Prepared by: Bill Travnicsek	Butt-Fusion	<a href="#">Supersedes:</a> 7-11-11
Approved by: Jeff Loll		Effective: 10-1-12

- 8. Inserting Heater - Heater Is Not Explosion Proof.** Operation of heater in a hazardous environment without necessary safety precautions will result in explosion and death.

If operating in a hazardous environment, heater should be brought up to temperature in a safe environment, then unplugged before entering the hazardous atmosphere for fusion.

Use a clean non-synthetic cloth to clean the butt fusion heater adapter surfaces.

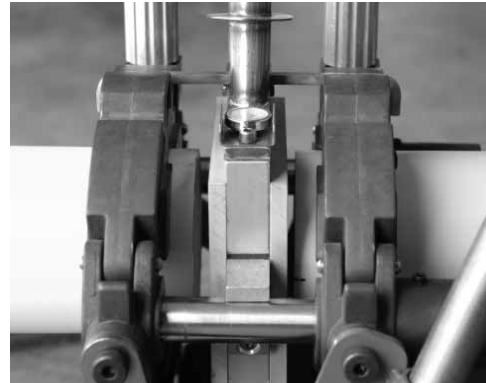

*Place the heating tool between the component ends and rest the heater pegs in the grooves on top of the clamps or if the heater has a stripper bar the downward legs should be on the outside of the jaws not on top.*

- 8. Heating the Pipe -** With heater in position between the pipe ends, snap pipe ends sharply against the heater to ensure alignment. Raise the locking cam into the engaged position or use fingers to apply light pressure while in the heating cycle.

*The bead size is dependent on the pipe size. Refer to Table 1 in Section E for bead size for each size of pipe. During the heating cycle, the melt bead will expand out flush to the heating tool surface, or may curl slightly away from the surface. If the melt bead curls significantly away from the heating tool surface, unacceptable pressure during heating may be indicated.*



- 9. Fusing the Pipe -** When the proper melt bead size is formed, quickly separate the ends, and remove the heating tool. Do not drag the heater face across the molten plastic. **QUICKLY** inspect the melted ends, which should be flat, smooth, and completely melted. A concave melt surface is unacceptable; it indicates pressure during heating. Do not continue. Allow the component ends to cool and start over with **Loading Pipe Into Machine**. See the following photograph.

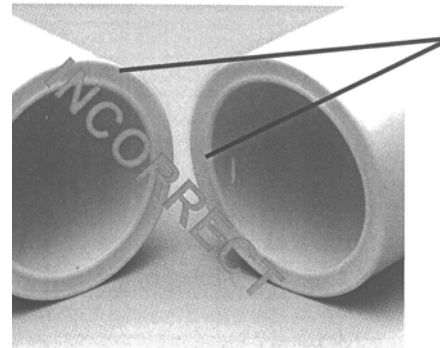

*If the melt surfaces are acceptable, immediately and in a continuous motion, bring the ends together and apply the correct joining force which is sufficient to form a double rollback bead against the pipe wall. Do not slam the pipe ends together.*

Hold this force for at least 10 seconds.

After 10 seconds, the locking cams will assist by holding force during the cooling cycle.

Failure to follow pipe manufacturer's heating time, pressure and cooling time may result in a bad joint.

<b>METROPOLITAN UTILITIES DISTRICT</b>	<b>Construction Standard</b>	No: <b>11.2.3</b>
		Page: 7 of 8
Prepared by: Bill Travnicek	Butt-Fusion	<a href="#">Supersedes:</a> 7-11-11
Approved by: Jeff Loll		Effective: 10-1-12

**E. BEAD SIZE**

**Table 1 Approximate Melt Bead Size**

Pipe Size	Approximate Melt Bead Size
1 ¼" IPS	1/32" – 1/16"
2" – 3" IPS	1/16" – 1/8"
4" – 8" IPS	1/8" – 3/16"
10" – 12" IPS	3/16" – 1/4"
16" – 18" IPS	1/4" – 7/16"

**F. HOLD (COOLING TIME)** - Hold joining force against the ends until the joint is cool to the touch. For the initial cooling time, the pipe ends must be held together in the McElroy 14 Machine either by flipping the spring loaded slide locking device or holding the slide handle. The pipe ends are held together with hydraulics when using the 28 and 618 machines. The joint is cool enough for GENTLE handling when the double bead is cool to the touch. Do not try to shorten cooling time by applying water or wet cloths.

Avoid pulling, installation, pressure testing and rough handling for at least an additional 30 minutes.

**G. INSPECT** - On both sides, the double bead should be rolled over to the surface and be uniformly rounded and consistent in size all around the joint. The double bead width should be 2 to 2-1/2 times its height above the surface and the v-groove depth between the beads should not be more than half the bead height.

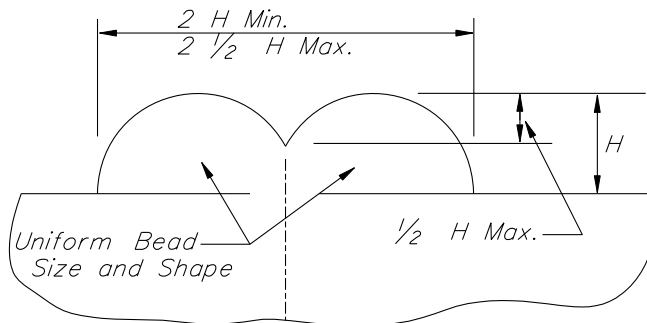

**Note:** When butt fusing to molded fittings, the fitting side bead may have an irregular appearance. This is acceptable provided the pipe-side bead is correct.

<b>METROPOLITAN UTILITIES DISTRICT</b>	<b>Construction Standard</b>	No: <b>11.2.3</b>
	<b>Butt-Fusion</b>	Page: 8 of 8
<a href="#">Supersedes:</a> 7-11-11		
Effective: 10-1-12		
Prepared by: Bill Travnicek		
Approved by: Jeff Loll		

## **H. TROUBLESHOOTING GUIDE**

**Table 2 - Butt Fusion Bead Troubleshooting Guide**

<i>Observed Condition</i>	<i>Possible Cause</i>
<i>Excessive double bead</i>	<i>Overheating; Excessive joining force</i>
<i>Double bead v-groove too deep</i>	<i>Excessive joining force; Insufficient heating; Pressure during heating</i>
<i>Flat top on bead</i>	<i>Excessive joining force; Overheating</i>
<i>Non-uniform bead size around pipe</i>	<i>Misalignment; defective heating tool; Worn equipment; Incomplete facing</i>
<i>One bead larger than the other</i>	<i>Misalignment; Component slipped in clamp; Worn equipment; Defective heating tool; Incomplete facing</i>
<i>Beads too small</i>	<i>Insufficient heating; Insufficient joining force</i>
<i>Bead not rolled over to surface</i>	<i>Shallow v-groove – Insufficient heating &amp; insufficient joining force; Deep v-groove – Insufficient heating &amp; insufficient joining force; Deep v-groove – Insufficient heating &amp; excessive joining force</i>
<i>Beads too large</i>	<i>Excessive heating time</i>
<i>Squareish outer bead edge</i>	<i>Pressure during heating</i>
<i>Rough, sandpaper-like, bubbly, or pockmarked melt bead surface</i>	<i>Hydrocarbon contamination</i>

## **I. COLD OR WET WEATHER FUSION**

*Remove frost, ice, or snow from the inside and outside surfaces of the pipe. Wipe with a clean dry cloth.*

*Protect the fusion process from the effects of rain and wind. Always keep the pipe clean and dry when fusing.*

*Follow the regular butt-fusion steps in cold weather. The additional time required to form the initial melt bead will automatically extend the total melt time.*